



rugged. interactive

TriggerTrac

2-Lane Version

Order and Installation Manual

For models from March 2019 onwards



Rugged Interactive

Unit 1, Callywith Court
Callywith Industrial Estate, Bodmin
Cornwall, UK
PL231 2RQ

+44 (0) 1726 981 123
www.rugged-interactive.co.uk
hello@rugged-interactive.co.uk

Updated: 31/07/2023



Rugged Interactive

Unit 1, Callywith Court
Callywith Industrial Estate, Bodmin
Cornwall, UK
PL31 2RQ

+44 (0) 1726 981 123

www.rugged-interactive.co.uk

hello@rugged-interactive.co.uk

Contents

Section 1 – Ordering Process

- 1.1 Need to Know
- 1.2 Order and Installation Checklist
- 1.3 Product Overview
- 1.4 Ordering and Installation Timeline
- 1.5 Getting Started
- 1.6 Place Order

Section 2 – Safety Guidelines

- 2.1 Installation Safety Guidelines
- 2.2 In Play Safety Guidelines

Section 3 – Installation

- 3.1 Parts List
- 3.2 Tools and Components List
- 3.3 Installation Overview
- 3.4 Detailed Installation

Section 4 – How to Use

Section 5 – Programs Guide

TriggerTrac System Specifications

TriggerTrac Installation Checklist

Next Steps



Rugged Interactive

Unit 1, Callywith Court
Callywith Industrial Estate, Bodmin
Cornwall, UK
PL31 2RQ

+44 (0) 1726 981 123
www.rugged-interactive.co.uk
hello@rugged-interactive.co.uk

Section 1 – Ordering Process

1.1 - Need to Know

Installation manual purpose and limitations

This manual is intended to provide guidance only, the installation of the Rugged Interactive product will be under your control. You will be responsible for making sure, upon completion of the installation, it is safe to use. As always, we are here to support you, please get in touch if you are in any doubt.

Regulations

Some countries and states have regulations which may be applicable to the Rugged Interactive products, it is your responsibility to check that the product complies with such regulations. This should be conducted during the planning phase for the installation location.



Rugged Interactive

Unit 1, Callywith Gate
Callywith Industrial Estate, Bodmin
Cornwall, UK
PL31 2RQ

+44 (0) 1726 981 123
www.rugged-interactive.co.uk
hello@rugged-interactive.co.uk

1.2 - Order and Installation Checklist

- Contact the Rugged Interactive sales team or a partner / distributor to begin the process.
- Confirm the invoice and delivery address along with date required (lead time is at least 5 weeks), VAT number required for export customers.
- Complete site survey.
- Send purchase order or confirm order.
- Make first payment.
- Discuss graphic requirements and provide logos and branding guidelines.
- Approve graphics.
- Make second payment (required a week before dispatch).
- Schedule time and team members for installation.
- Before install, confirm all tools and components are prepared.
- Organise shipment (Customer collection or delivery organised by Rugged Interactive).
- Receive your order.
- Install the product.
- Test and complete installation checklist.
- Train the team on how to use the product.
- Sounds can be heard when the targets are hit.
- Reveal your new Rugged Interactive product to your guests and customers!



Rugged Interactive

Unit 1, Callywith Gate
Callywith Industrial Estate, Bodmin
Cornwall, UK
PL31 2RQ

+44 (0) 1726 981 123
www.rugged-interactive.co.uk
hello@rugged-interactive.co.uk

1.3 - TriggerTrac Overview

A raceway timer for ninja runs and obstacle courses featuring LED lights and sounds along with a super accurate timer.

The 2-Lane TriggerTrac pits users against each other. Featuring one start button that begins both lanes timers, race down the course to be the first to hit their finish panel, stopping the timer, once the second placed user finishes, both times are displayed side by side with the winning time flashing.

Combine TriggerTrac with a Top Gear style leader board from Rugged Interactive and display the fastest times for posterity.

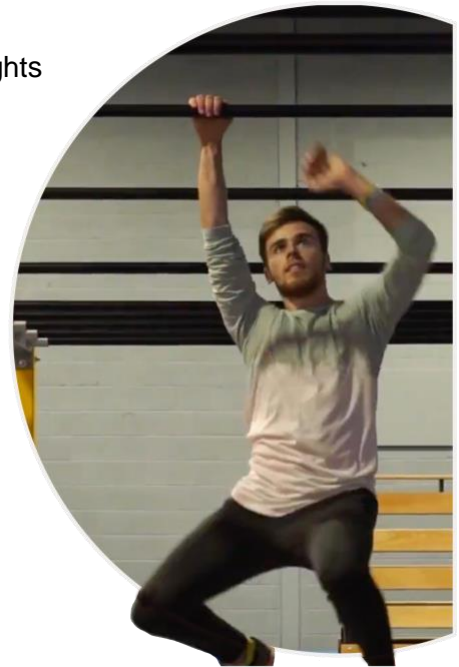

1.4 - Order and Installation Timeline

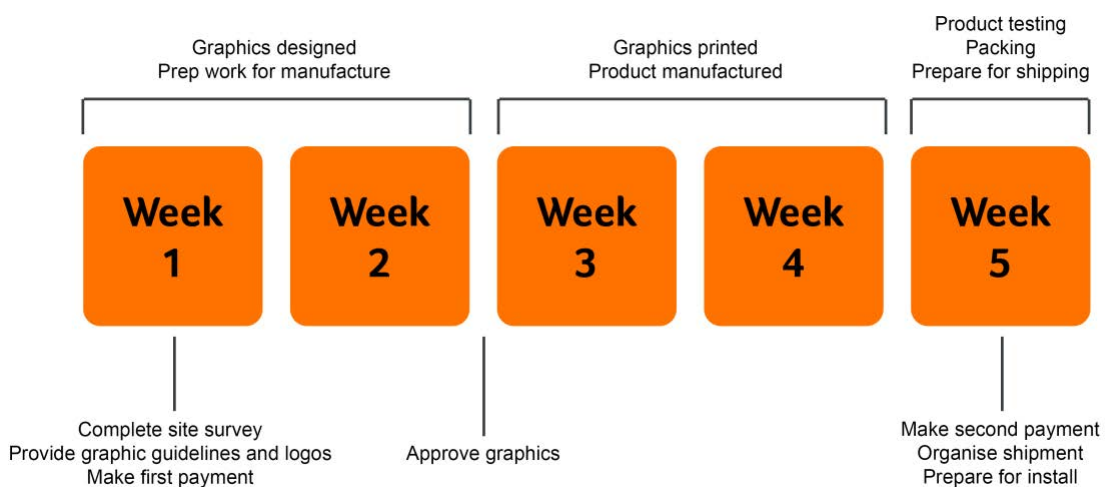

*We do our best to ensure orders are ready on a five-week lead time, however during busy periods or for large orders, the lead time may be longer than outlined here. Lead time will also be affected by graphics guidelines, approval and payment delays.



Rugged Interactive

Unit 1, Callywith Court
Callywith Industrial Estate, Bodmin
Cornwall, UK
PL31 2RQ

+44 (0) 1726 981 123
www.rugged-interactive.co.uk
hello@rugged-interactive.co.uk

1.5 - Getting Started

New Parks

During the design process for the new park, incorporate the intended products into the design, product specifications can be found within this manual for the relevant product and CAD files can be supplied upon request.

Existing Parks

When retrofitting existing parks, all specifications can be found within this manual or CAD files are available at request. If further information is required, please get in touch and we will be able to provide further information and guidance.

1.6 - Place Order

To begin the order process with Rugged Interactive:

Email:

Sales@rugged-interactive.co.uk

Or call the Sales Office:

+44 (0) 7585 955 184

HQ/Production Address:

Unit 1 Callywith Court
Callywith Ind. Estate,
Bodmin,
Cornwall
UK
PL31 2RQ

Sales Office Address:

Rugged Interactive,
Future Space,
UWE North Gate,
Filton Road,
Bristol,
UK
BS34 8RB



Rugged Interactive

Unit 1, Callywith Court
Callywith Industrial Estate, Bodmin
Cornwall, UK
PL31 2RQ

+44 (0) 1726 981 123
www.rugged-interactive.co.uk
hello@rugged-interactive.co.uk

Section 2 - Safety Guidelines

2.1 Installation Safety Guidelines

Before installing any Rugged Interactive product, please read the following:

Dos:

- Ensure that a Site Survey form has been completed prior to installation.
- Have ready suitable equipment, tools and/or man power.
- Observe correct manual handling techniques whilst moving and installing the equipment.
- If being installed onto a wall, the product **MUST** be mounted onto a wall of a construction capable of supporting its weight and gameplay. If possible, avoid stud walls or unsupported portal infills. If in doubt always contact a suitably qualified surveyor to check.
- Visually check the product for any signs of damage, component failure and/or missing parts.
- To prevent electric shock, keep all electric components away from contact with water.
- Ensure to take anti-static precautions.
- Wear appropriate clothing: do not wear loose clothing or jewellery.
- Long hair should be tied back.
- Tidy back loose cables that could become a tripping hazard.
- Ensure that the playing area is clear.
- Immediately inform Rugged Interactive for maintenance advice if you have concerns.

Don'ts:

- Do not wear shoes with leather soles or high heels.
- Do not use any tools that are not specifically recommended by the manufacturer.
- Do not use the surface of the trampoline to balance ladders or alike.
- Do not distract others while they are installing the product.

2.2 In Play Safety Guidelines

Please ensure you read the following points before using the equipment:

This activity can be great fun, but it can also be dangerous. There is a risk of serious injury if care is not taken when using the equipment. Use of this equipment is physically demanding: this is a high-impact, full body activity which requires intense focus, awareness of your body's strengths and limitations, awareness of the environment around you and extreme caution.

Dos:

- Before beginning any exercise program, it is recommended that you consult with your doctor.
- Children under the age of 7 years must always be supervised by an adult (over 16 years) when using the equipment and/or recommended accessories.
- Visually check the equipment before using it for any signs of damage, component failure or loose cables that could become a tripping hazard. Report any concerns, e.g. loose holds or damaged equipment, to a member of staff immediately.
- Ensure you familiarise yourself with any additional facility rules that may apply.
- Ensure that the play area is clear before attempting to participate.
- Only participate if you are in good physical condition. Participate only within your capabilities / recommended exercise level.
- Wear appropriate clothing.
- Remove all items from your pockets prior to participation.
- Long hair should be tied back.
- Before use, loosen up with warm up exercises and stretches.
- Always remain in control. Uncontrolled jumps or falls are likely to result in injuries to yourself and/or others.
- Only those participating are allowed in the activity area. If waiting to participate, stand back at a safe distance from the equipment.
- Report any unusual or inappropriate behaviour to a member of staff immediately.
- If you get tired, leave the equipment / activity area and take a break.
- If you feel any pain, dizziness, nausea or any other abnormal symptoms, STOP YOUR WORKOUT IMMEDIATELY. Consult your doctor immediately. Incorrect or excessive training may lead to injuries.

Don'ts:

- Do not attempt to use any of the equipment without undertaking instruction / training carried out by an appropriate instructor.
- Do not participate if you are unwell or have any pre-existing medical conditions including heart, back, neck, bone and/or muscle conditions.
- Do NOT work to exhaustion.
- Do not participate if you are or maybe pregnant.
- Do not wear loose clothing or jewellery (including studs and watches). Clothing should not have any hard or sharp points (such as buckles, studs, toggles or alike).
- Do not wear shoes with leather soles, high heels, sandals, boots or bare feet.
- No food, drink or chewing gum during participation.
- No phones or cameras in the activity area.
- Do not leave clothing or personal belongings around the activity areas.
- Do not participate under the influence of alcohol and/or drugs.
- Do not attempt any move beyond your own skill level.
- Do not distract others while they are using the equipment.
- Do not sit, lie, stand or rest on or under the activity equipment and/or surrounding padding/mats.
- Never lean on, jump on, climb, grab, or lift any safety pads or safety nets.
- Do not use any accessories that are not specifically recommended by the manufacturer. These might cause injuries or cause the equipment to fail.



Rugged Interactive

Unit 1, Callywith Gate
Callywith Industrial Estate, Bodmin
Cornwall, UK
PL31 2RQ

+44 (0) 1726 981 123
www.rugged-interactive.co.uk
hello@rugged-interactive.co.uk

Section 3 - Installation

3.1 - Parts List

Please check off the received parts for the installation and alert Rugged Interactive immediately if anything is missing.

- | | |
|--|--------------------------|
| 2 x Finish targets. | <input type="checkbox"/> |
| 1 x Hub control box. | <input type="checkbox"/> |
| 4 x Control box mounting brackets including 12 x M5 x 12mm screws. | <input type="checkbox"/> |
| 2 x 30m finish target connection cables. | <input type="checkbox"/> |
| 1 x Start button | <input type="checkbox"/> |
| 1 x 30m Red start button connection cable. | <input type="checkbox"/> |
| 12 x M8 x 80 target fixing bolts. | <input type="checkbox"/> |
| 12 x M8 nuts. | <input type="checkbox"/> |
| 12 x M8 washers | <input type="checkbox"/> |
| Manual. | <input type="checkbox"/> |

3.2 - Tools and Components List

Arrange the necessary tools and the team to install the product.

- Ladder.
- Jigsaw.
- Hole saw.
- Industrial vacuum cleaner.
- Dustpan and brush.
- SDS impact drill.
- Cordless drill – with torque adjuster to avoid over-tightening the screws.
- A set of No.2 Pozi bits.
- A set of screwdrivers.
- A set of Hex keys



Rugged Interactive

Unit 1, Callywith Court
Callywith Industrial Estate, Bodmin
Cornwall, UK
PL31 2RQ

+44 (0) 1726 981 123
www.rugged-interactive.co.uk
hello@rugged-interactive.co.uk

3.3 - Installation Overview

Below is an overview of the steps needed to install TriggerTrac. More detail for the process is provided in the following pages. Please read through ALL of this prior to beginning the installation and if you are in any doubt, contact Rugged Interactive.

If you have any concerns on how or what the product is installed to, contact a structural engineer prior to beginning the installation.

STEP 1: Mark out position for the finish targets and scoreboard.

STEP 2: Cut necessary holes.

STEP 3: Mount scoreboard and start button.

STEP 4: Run cables from scoreboard to finish targets.

STEP 5: Mount finish targets.

STEP 6: Turn on TriggerTrac system.

STEP 7: Test.

STEP 8: Check all is secured.

STEP 9: Stress relief cables.

STEP 10: Enjoy TriggerTrac!



Rugged Interactive

Unit 1, Callywith Court
Callywith Industrial Estate, Bodmin
Cornwall, UK
PL31 2RQ

+44 (0) 1726 981 123

www.rugged-interactive.co.uk

hello@rugged-interactive.co.uk

3.4 – Detailed Installation

Read this manual before installing TriggerTrac.

Installation Guidelines:

- Complete the Site Survey form prior to delivery and/or installation.
- Send a completed Installation Checklist after any installation to Rugged Interactive.
- A typical installation should take 2 people about 3 hours.
- No obstructions or protrusions in the installation area: e.g. skirting boards, pipes, cables and wiring conduits.
- Avoid trapped and/or pinched cables.
- Use good practice when running data cables to and from products, external pods and sensors. Support long cables at least every 50 cm and provide adequate strain relief for connection points.
- To prevent electric shock, keep all electric components away from contact with water.
- IMPORTANT: Take anti-static precautions.

Structure:

- TriggerTrac is supplied as 1 x start button and up to 2 x stop pressure panels (stop buttons) plus 1 x Hub display box and appropriate cables.
- The start button can be fitted in any orientation - onto an appropriately sized plinth or post, or onto a vinyl padded wall - so long as their CAT5 cable is fed back to the distribution box.
- The pressure panels should be mounted to a plywood wall (min 12mm) which has a 70mm recess behind. Two 502 x 242mm holes must be cut at a suitable height for the pressure panel to be mounted to the wall.
- The units must be mounted to a flat/level construction capable of supporting their weight and gameplay. (Uneven walls and surfaces make alignment and fitting very difficult.)
- Mount onto 18 mm plywood (12 mm minimum) mechanically mounted to a steel framework (50 mm box minimum). The plywood should be covered with foam-backed vinyl.
- Units can either be secured on top of the foam-backed vinyl or embedded in a purpose-made cut-out. Adequate holes will need to be cut during installation to provide clearance for cable access to rear if required.

Fixings:

- The manufacturer will supply fixings.
- All fixings must be tight and secure.

Suggested Extras:

- 3 m of self-adhesive 'mini' box trunking to secure the power cable.
- Cleaning cloth and gentle cleaning spray.

Operating Environment:

- Keep out of direct sunlight; bright sunlight can affect the LED pod sensors.
- Keep indoors and dry.
- Optimum ambient temperature: 5°C to 30°C. Avoid extreme fluctuations of temperature.

Other Recommendations:

- Instruction / training carried out by an appropriate instructor to all new users.
- A waiting / spectating area positioned nearby is advised.
- A leaderboard to go with each unit is highly recommended.

IF YOU ARE IN ANY DOUBT, CALL RUGGED INTERACTIVE DIRECTLY ON +44 (0) 1726 833 882.

TriggerTrac Display / Score Box (HUB) Installation

Notes:

- Fix HUB using any suitable self-tapping or wood screws into the surface material. The HUB can be recessed to be flush with the surface or affixed on top of the foam-backed vinyl if necessary.
- A central position is recommended for easy comparison of scores.
- **Note:** Cables exit is at the rear of the display box as standard, however this can be adjusted, if necessary, by removing the pop out on the bottom edge and sliding the cables and rubber grommet around to the new position.

01

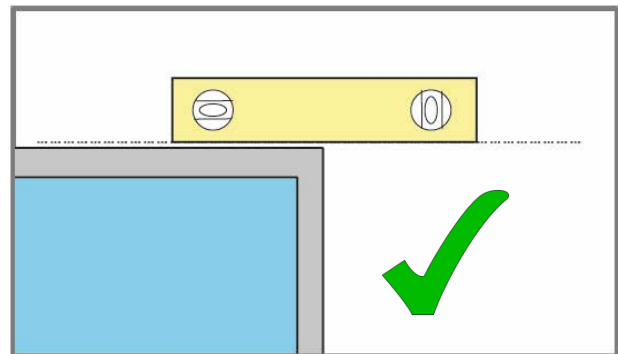
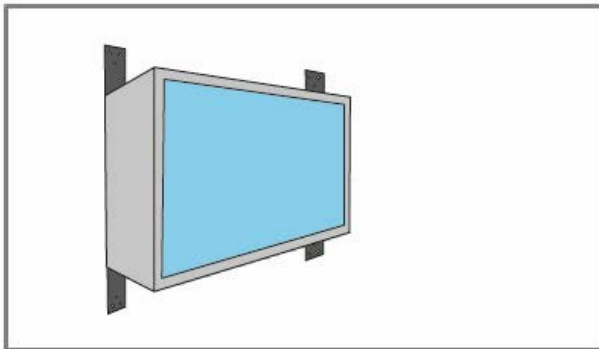

Hold the main body in place, and ensure it is level.

02

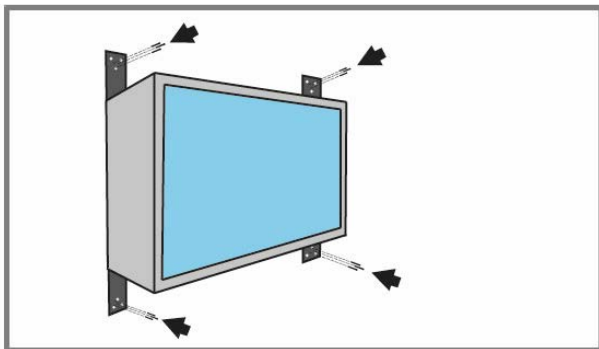

Use appropriate fixings and mount the display box to the wall.

Note: Make sure everything is tight and secure and that no cables are trapped.

TriggerTrac Start Button Installation

Notes:

- Fix the Start Button as per the instructions below.
- Fix to a pre-padded pole.
- A position next to the entrance of the TriggerTrac arena is recommended for ease of use.

01



Position pod on the exposed pole in the desired orientation.

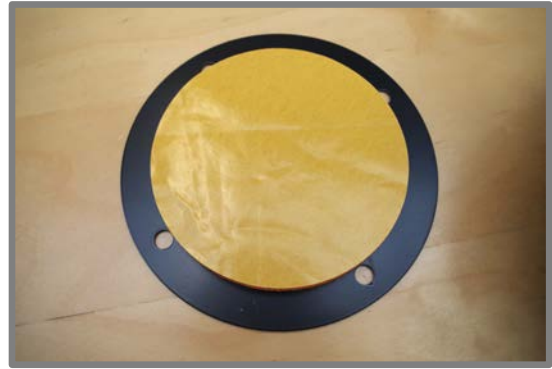

Remove cover from adhesive pad and align to the rear of the pod.

02

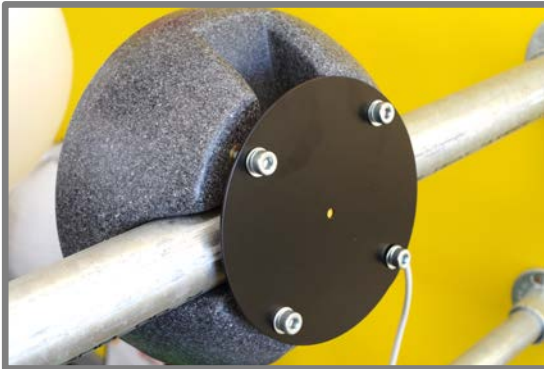

Attach bolts and tighten until firmly in place.

03

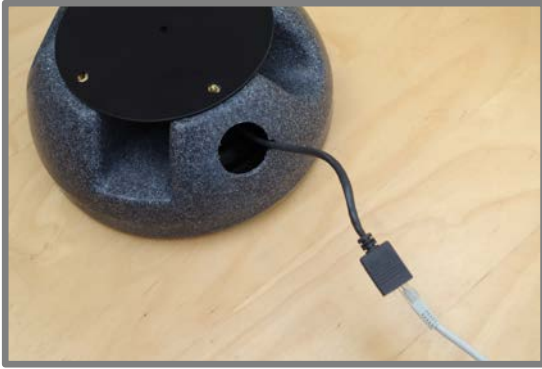

Connect appropriate length CAT5 cable to the start button's hanging cable that will return to the control box. The start button must be within 30m of the control box.

04



Tuck the hanging cable and head of the CAT5 cable inside the recess in the moulding. Cable excess can be fed into this recess too.

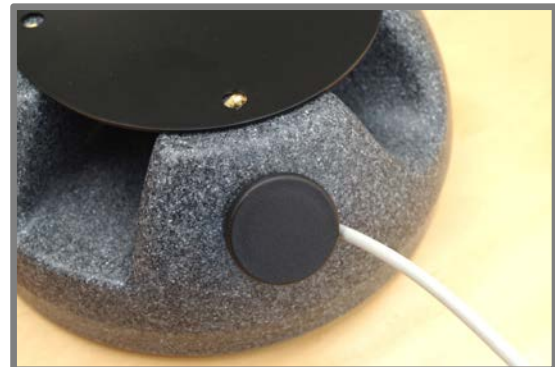

Push the supplied stopper into the hole being sure the cable is sitting in the small recess to the side of the main hole.

05



Ensure all fixings are secure and all cables are tidy. Add padding to poles as appropriate.

Pressure panels / stop button Installation

Notes:

- One stop button for each player, stops their time.
- Fit in line with the lane for user.
- **Note:** Cables exit is at the rear of the pressure panel box.

01

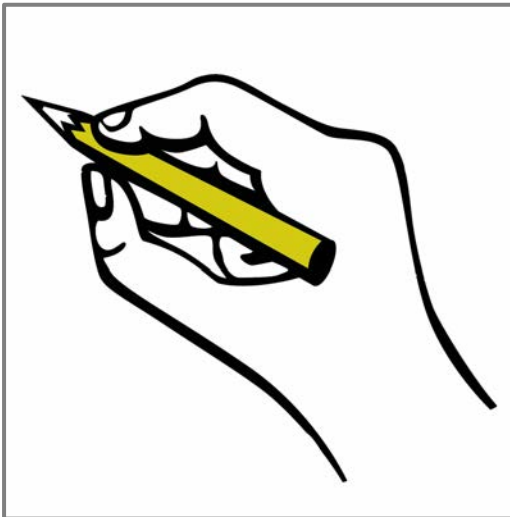

Mark out and cut the recesses for the two pressure panels, the holes are to be 502 x 242mm each.

02

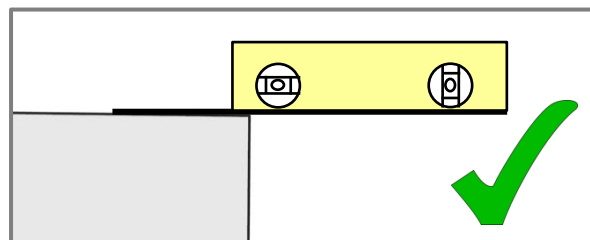
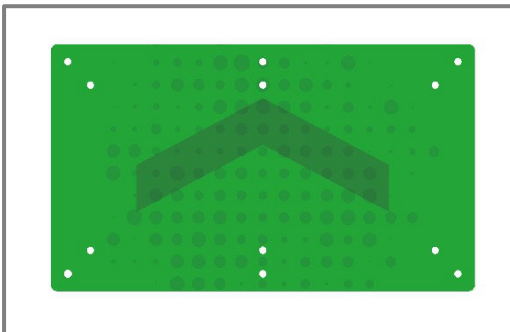

Mount each pressure panel, they contain hanging cables, connect the CAT5 cables and then connect into their corresponding positions on the HUB.

Connecting cables

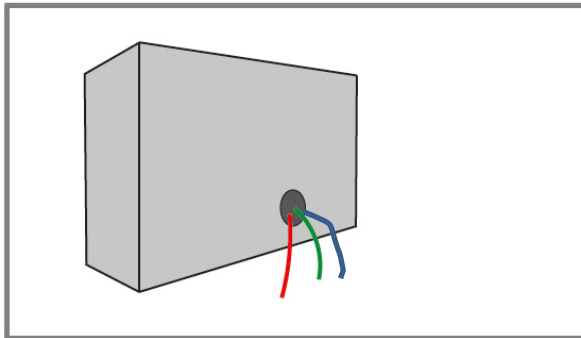

The Hub will have three hanging cables labelled for the start button and player one and two stop pressure panels. Attach CAT5 cable from hanging cable to appropriate button.

NOTE: Please use good practice when running data cables to and from products, targets and boxes. Support long cables at least every 50 cm and provide adequate strain relief for connection points.

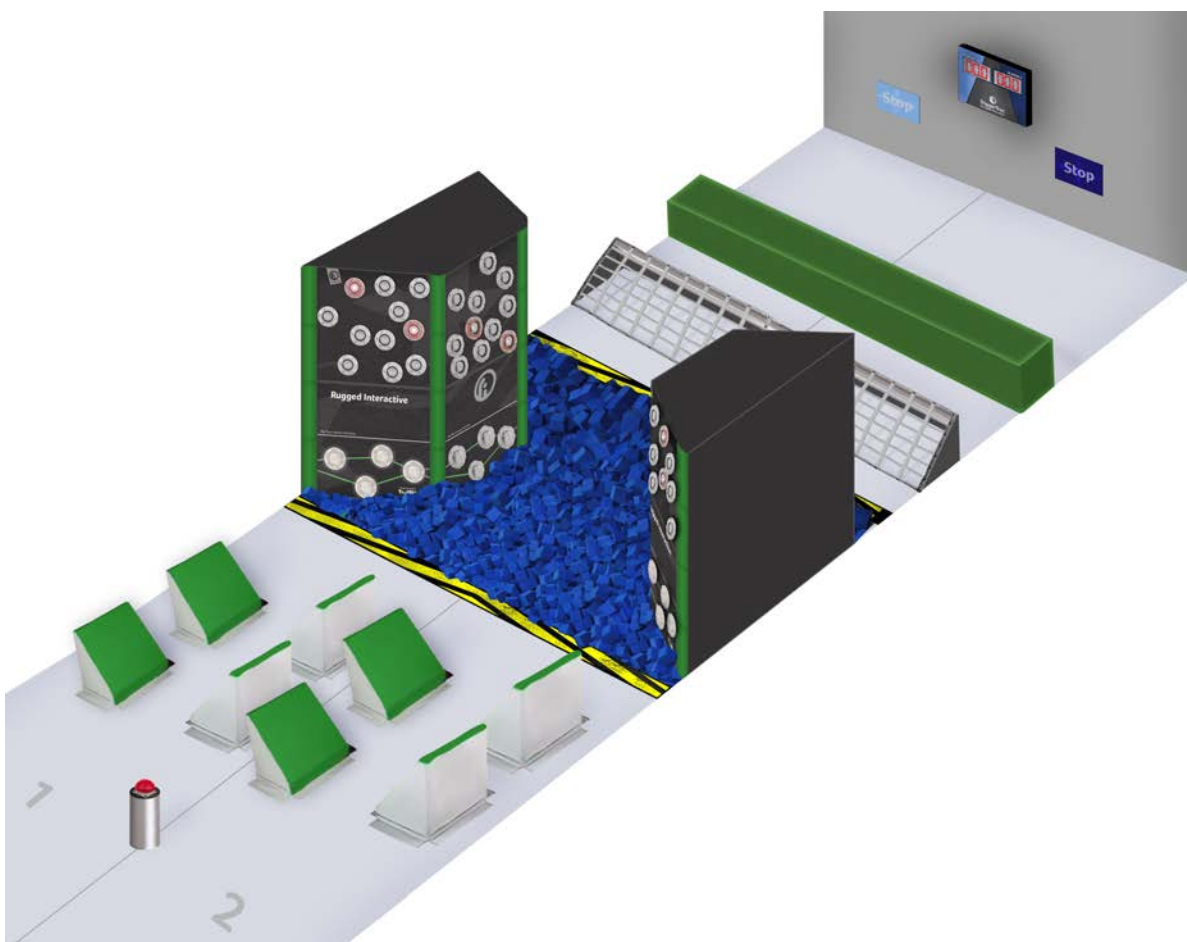

Figure 3.4.2: Typical TriggerTrac Layout

Adjusting the Sensitivity

Notes:

- A small flat-bladed screwdriver is required.
- Do not over tighten, this can damage the sensors, a maximum of a quarter turn in the appropriate direction should be made each time before retesting.

The sensitivity should be checked and if necessary, adjusted after installation of the targets. Each target has its own sensor, so each one should be checked.

To adjust the sensitivity, locate the hole on the reverse of the targets. There will be a screw as can be seen in **Figure 3.4.3**. Using a small flat-bladed screwdriver turn the screw in the desired direction, clockwise to increase the sensitivity, Anti-clockwise to decrease. Turn a quarter turn before retesting the sensitivity and repeat if required.

Do not over tighten the screw, this can damage the sensor.



Figure 3.4.3: Location to adjust the sensitivity



Rugged Interactive

Unit 1, Callywith Court
Callywith Industrial Estate, Bodmin
Cornwall, UK
PL31 2RQ

+44 (0) 1726 981 123
www.rugged-interactive.co.uk
hello@rugged-interactive.co.uk

Section 4 - How to Use

On power up, TriggerTrac will make a “laugh” sound and the software version will be displayed on the Hub before going to its idle state. The display will show two timers, on first start-up these will both show 00.0.

TriggerTrac has one 2-player program.

Hit the start button to start the time. TriggerTrac will sound a whistle.

Players will race down either track to get to their stop panel first.

When the first finisher hits their pressure panel, TriggerTrac will sound a ‘horn’. Their time will be shown on their side of the display, either player 1 or player 2 depending on the lane.

When the second finisher hits their pressure panel, TriggerTrac will sound a ‘party horn’. Their time will be shown on their side of the display, either player 1 or player 2 depending on the lane.

The quicker time will flash.

If the game has been started and no players are on the course, you can reset the timers, hold down the **start button** for 5 seconds and the timers will reset to 00.0.

If one or both of the timers reach 10 minutes, the game will reset to its idle state.

At the end of the game, the finishing times will be displayed for 30 seconds with the quicker time flashing before returning to its idle state, in these 30 seconds, the game can be played again by pressing the start button to start the timers from 00.0.



Rugged Interactive

Unit 1, Callywith Gate
Callywith Industrial Estate, Bodmin
Cornwall, UK
PL31 2RQ

+44 (0) 1726 981 123
www.rugged-interactive.co.uk
hello@rugged-interactive.co.uk

Section 5 - Programs Guide

TriggerTrac

- Summary:** A timer for obstacle and ninja courses which pits users head to head to be the first to complete the course.
- Gameplay:** Press the start button to begin the timers, race down the course and hit the finish target to stop your timer. The fastest time flashes.
- Aim:** To be the first to complete the course and stop the timer.
- Scoring system:** Accurate head to head timer.
- Duration:** Up to 10 minutes.

NOTE: At any time, if TriggerTrac behaves unexpectedly during gameplay, wait for the unit to reset to its idle state or press and hold the start button for 5 seconds.



Rugged Interactive

Unit 1, Callywith Court,
Callywith Industrial Estate,
Bodmin, Cornwall, UK
PL31 2RQ

+44 (0) 1726 981 123

www.rugged-interactive.co.uk

hello@rugged-interactive.co.uk

TriggerTrac System Specifications

Dimensions and Weights:

	Approx. Shipment Details		Fully Assembled Details	
	Size (mm)	Weight	Size (mm)	Weight
TriggerTrac (1 start button, 2 finish pressure pads, display / score box)	850 x 70 x 650 600 x 340 x 300 (2 boxes)	20 kg (per box)	-	-
Start button (single unit)	-	-	100 x 100 x 100	1 kg
Display / Score Box (HUB) (single unit)	-	-	850 x 70 x 586	20 kg
Pressure Panels (Stop Button) (single unit)	-	-	600 x 75 x 340	5 kg

Power Supply:

AC: 110-230V, 50-60Hz, 13A

Warranty:

1 year on electronics. 3 years on all other parts.

Regulatory Requirements:

CE Approved.

Operating Environment:

Indoors: keep dry and out of direct sunlight.

Mount to a wall of a suitable construction.

Optimum ambient temperature: 5°C to 30°C. Avoid extreme temperature fluctuation.

Other:

All parts designed for easy maintenance.

Cut out sizes:

Each stop pressure pad will require a recess cut out of the wall for them to sit flush to the wall.

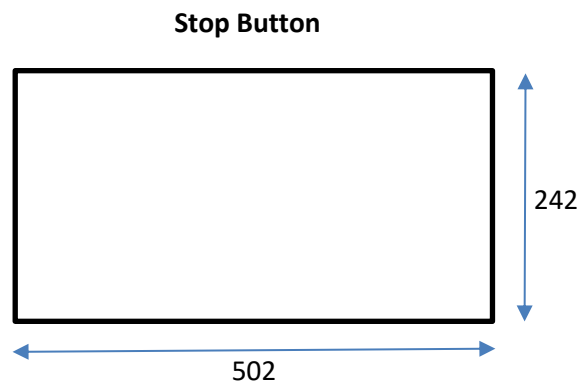

Figure 1: Stop button pressure pad cut out size required for installation. (+3 / - 0) cut tolerance. (Dimensions in mm)

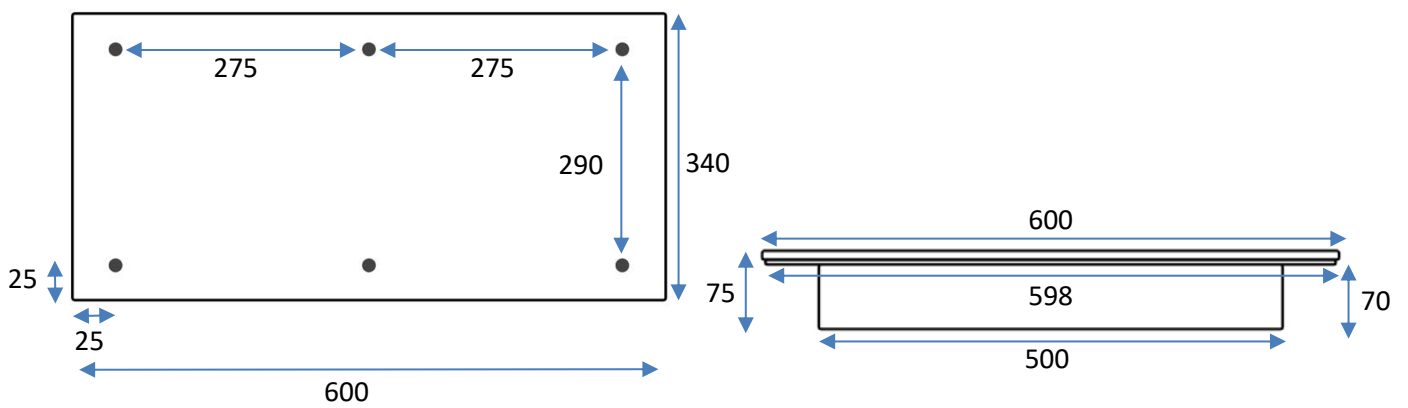
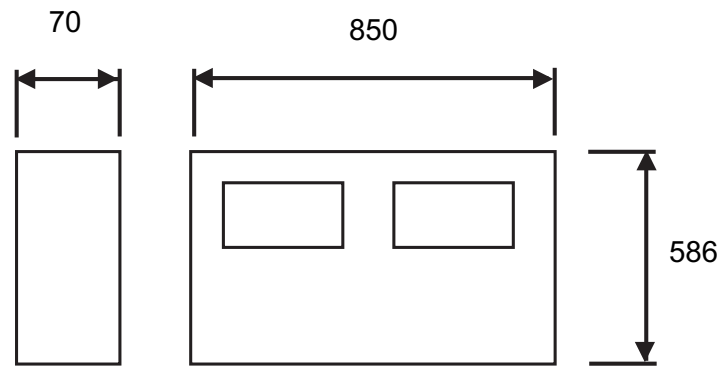
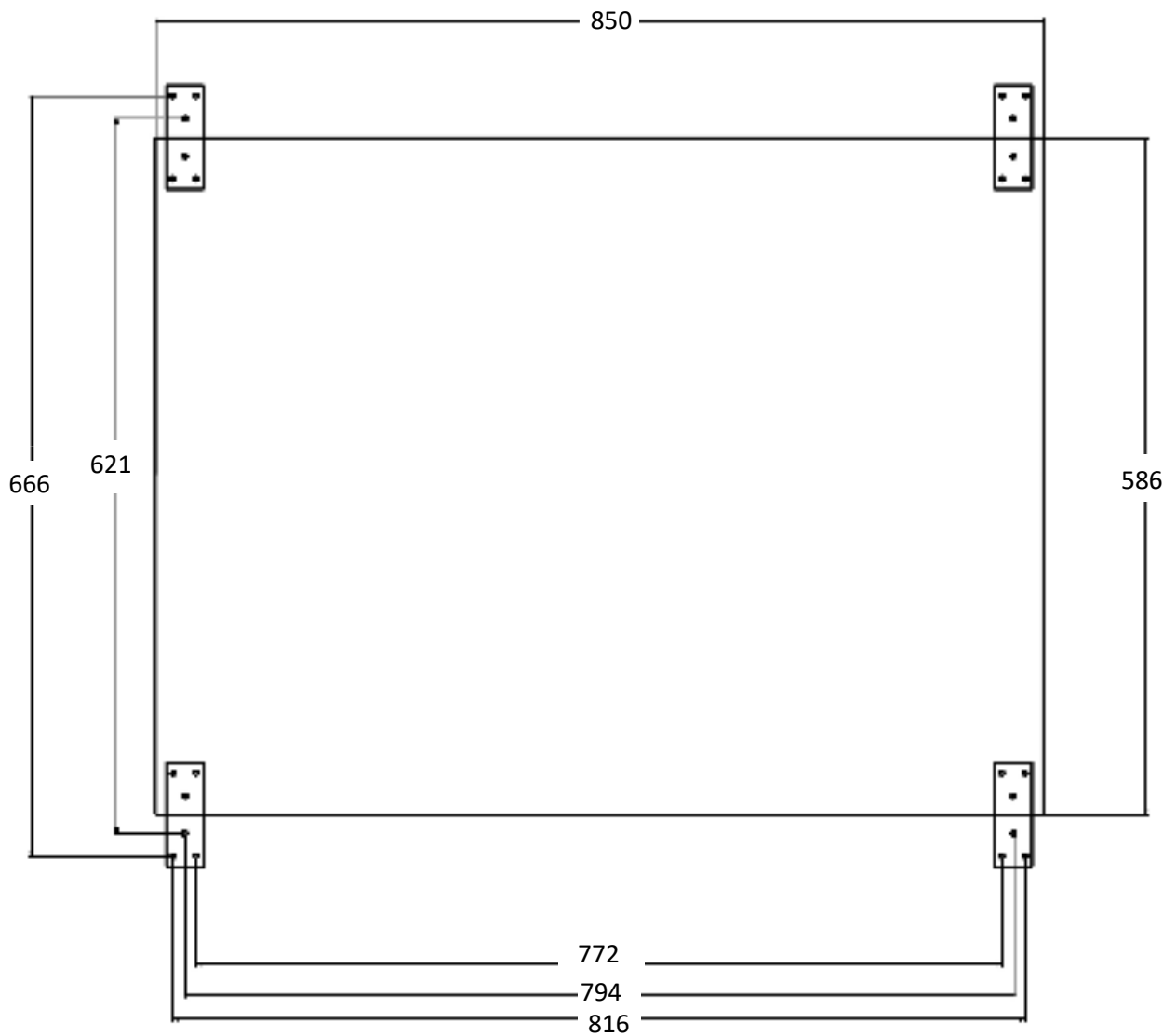

Figure 2: Target Mounting Points and Dimensions (Dimensions in mm)



Score Box (HUB) (Dimensions in mm)



Mounting Points for Score Box (Dimensions in mm)



■ Features

- Universal AC input / Full range
- 2 pole AC inlet IEC320-C8
- Medical safety approved (2 x MOPP between primary to secondary)
- Suitable for BF application with appropriate system consideration
- Low leakage current <50uA
- No load power consumption<0.1W
- Energy efficiency level VI(Except 5~9V for Level V)
- Comply with EISA 2007/DoE,NRCan, AU/NZ MEPS, EU ErP and meet CoC Version 5
- Built-in active PFC function
- High efficiency up to 91.5%
- Fanless design with -30~+60°C working temperature
- Class II power (without earth pin)
- Protections: Short circuit / Overload / Over voltage / Over temperature
- Fully enclosed plastic case
- LED indicator for power on
- 100% full load burn-in test



Power Supply Specification

SPECIFICATION

PRODUCT		GSM60B12-P1J	
OUTPUT	SAFETY MODEL NO.	GSM60B12	
	DC VOLTAGE <small>Note.2</small>	12V	
	RATED CURRENT	5A	
	CURRENT RANGE	0 ~ 5A	
	RATED POWER (max.)	60W	
	RIPPLE & NOISE (max.) <small>Note.3</small>	100mVp-p	
	VOLTAGE TOLERANCE <small>Note.4</small>	± 3.0%	
	LINE REGULATION <small>Note.5</small>	± 1.0%	
	LOAD REGULATION	± 3.0%	
	SETUP, RISE TIME <small>Note.6</small>	1000ms, 30ms / 230VAC 1500ms, 30ms / 115VAC at full load	
HOLD UP TIME (Typ.)	50ms / 230VAC 15ms / 115VAC at full load		
INPUT	VOLTAGE RANGE <small>Note.7</small>	80 ~ 264VAC 120 ~ 370VDC	
	FREQUENCY RANGE	47 ~ 63Hz	
	EFFICIENCY (Typ.)	88%	
	AC CURRENT (Typ.)	1.4A / 115VAC 1A / 230VAC	
	INRUSH CURRENT (Typ.)	30A / 115VAC 65A / 230VAC	
	LEAKAGE CURRENT(max.)	Touch current < 50µA/264VAC	
PROTECTION	OVERLOAD	105 ~ 160% rated output power Protection type : Hiccup mode, recovers automatically after fault condition is removed	
	OVER VOLTAGE	12.6 ~ 16.2V Protection type : Shut down o/p voltage, re-power on to recover	
	OVER TEMPERATURE	Shut down o/p voltage, re-power on to recover	
ENVIRONMENT	WORKING TEMP.	-30 ~ +60°C (Refer to "Derating Curve")	
	WORKING HUMIDITY	20% ~ 90% RH non-condensing	
	STORAGE TEMP., HUMIDITY	-40 ~ +85°C, 10 ~ 95% RH	
	TEMP. COEFFICIENT	± 0.03% / °C (0 ~ 40°C)	
	VIBRATION	10 ~ 500Hz, 2G 10min./1cycle, period for 60min. each along X, Y, Z axes	
SAFETY & EMC (Note. 8)	SAFETY STANDARDS	ANSI/AAMI ES60601-1 / ES60601-1-11, TUV EN60601-1 / 60601-1-11 approved	
	ISOLATION LEVEL	Primary-Secondary: 2xMOPP	
	WITHSTAND VOLTAGE	I/P-O/P:4KVAC	
	ISOLATION RESISTANCE	I/P-O/P:100M Ohms / 500VDC / 25°C / 70% RH	
	EMC EMISSION	Compliance to EN55011(CISPR11) class B, EN61000-3-2,3, FCC PART 15 class B,CAN ICES-3(B)/NMB-3(B)	
	EMC IMMUNITY	Compliance to EN61000-4-2,3,4,5,6,8,11, EN55024, EN60601-1-2, EN61204-3 medical level, criteria A	
OTHERS	MTBF	720K hrs min. MIL-HDBK-217F(25°C)	
	DIMENSION	125*50*31.5mm (L*W*H)	
	PACKING	0.32Kg; 40pcs/13.8Kg/1.05CUFT	
CONNECTOR	PLUG	See page 3 ; Other type available by customer requested	
	CABLE	See page 3 ; Other type available by customer requested	
NOTE	<ol style="list-style-type: none"> All parameters are specified at 230VAC input, rated load, 25°C 70% RH ambient. DC voltage: The output voltage set at point measure by plug terminal & 50% load. Ripple & noise are measured at 20MHz by using a 12" twisted pair terminated with a 0.1uf & 47uf capacitor. Tolerance: includes set up tolerance, line regulation, load regulation. Line regulation is measured from low line to high line at rated load. Length of set up time is measured at first cold start. Turning ON/OFF the power supply may lead to increase of the set up time. Derating may be needed under low input voltages. Pleas check the derating curve for more details. The power supply is considered as an independent unit, but the final equipment still need to re-confirm that the whole system complies with the EMC directives. For guidance on how to perform these EMC tests, please refer to "EMI testing of component power supplies." (as available on http://www.meanwell.com) 		



Derating Curve

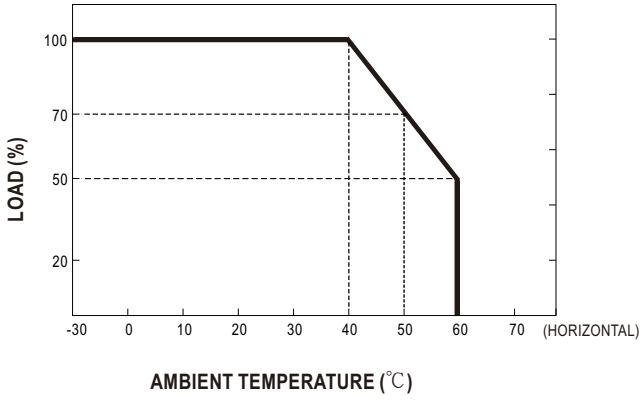

Static Characteristics

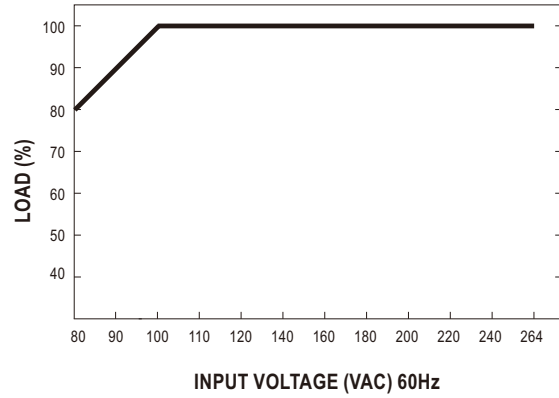

Mechanical Specification

Case No. GSM60B Unit:mm

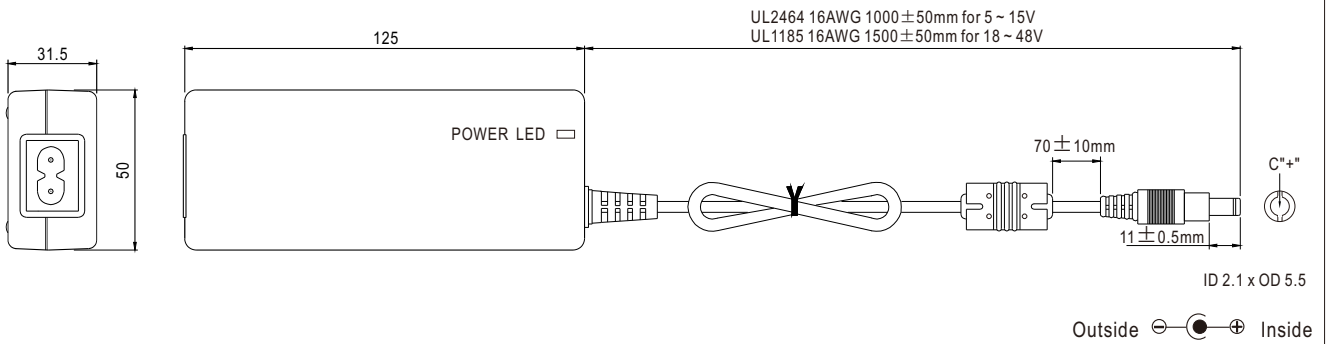

Plug Assignment

Standard plug: P1J

P1J	
P/N	OUTPUT
CENTER	+



Rugged Interactive

Unit 1, Callywith Court,
Callywith Industrial Estate,
Bodmin, Cornwall, UK
PL31 2RQ

+44 (0) 1726 981 123
www.rugged-interactive.co.uk
hello@rugged-interactive.co.uk

TriggerTrac Installation Checklist

Please complete this checklist after any installation:

Check 1: Pre-power up checks.

- Mounted onto a wall of a construction capable of supporting its weight and gameplay.
- All fixings are tight and secure.
- No signs of damage, component failure and/or missing parts.
- No trapped and/or pinched cables.
- No loose cables that could become a tripping hazard.
- All long cables are supported at least every 50 cm.
- Adequate strain relief provided for connection points.
- Kept out of direct sunlight during the day.
- All electric components away from contact with water.
- Protective plastic sheet from each button removed.

Check 2: Power up.

- All panels light up.
- Text appears on the hub display and is as expected. *E.g. timers*
- Sound volume is at a suitable level*.

Check 3: Select the Start button.

- Button active and operational.
- Sounds can be heard when the pod is hit.
- A whistle sounds and timers start.
- Program plays as described in the Programs Guide.

Check 4: Stop Pressure Panels.

- Panels active and operational.
- Timers stop when panel pressed.
- Sound heard when panel is pressed.

TriggerTrac Order and Installation Manual: *Installation Checklist*

Check panel for LED lights: white.

Check 5: Ready for use

Play area is clear.

Instruction / training carried out by an appropriate instructor to all new users.

If anything unexpected occurs or problems persist after troubleshooting, call Rugged Interactive directly on +44 (0) 1726 833 882.

* The volume can be adjusted on the main hub. The volume control (a small blue control) can be seen through the score window on the bottom left of the PCB. Rotate clockwise for volume up, counter-clockwise for volume down.





Rugged Interactive

Unit 1, Callywith Gate
Callywith Industrial Estate, Bodmin
Cornwall, UK
PL31 2RQ

+44 (0) 1726 981 123
www.rugged-interactive.co.uk
hello@rugged-interactive.co.uk

Next Steps

Train team members

Train your team members on how to use TriggerTrac, having knowledge of the gameplay will help them encourage users. Inspire them to cheer and celebrate with the customers when they achieve high scores.

Maintenance

General care and maintenance procedures for your Rugged Interactive product.

1. Inspect the product daily for any signs of damage or loose components. Repair or tighten as applicable.
2. Turn on the product, check the LEDs and sound is working as expected.
3. Start a game, check all pods/sensors work and react as expected. Please refer to the manual for instructions on gameplay.
4. If a pod has seven (7) or fewer working LEDs, we recommend replacing the pod.
5. We suggest non-solvent glass cleaning spray, avoid spraying directly onto the pods. Use a non-abrasive microfibre cloth and extremely light pressure when wiping the product. Too much pressure will scratch the graphics panel.
6. Only use accessories recommended by the manufacturer with the products. Accessories not recommended could cause serious damage.
7. Every three months check the fixings are tight.
8. Once a year, check the structure supporting the product is still solid.
9. We recommend turning the products off when they are not in use (close of business), this will help to extend the life of the product.

Marketing

With this being such an eye-catching product, it is excellent for use in posts on social media, either featuring in photos or videos.

If you would like any help, guidance or examples of using this product in your marketing campaign, please contact Rugged Interactive and we will be able to assist with this.



Rugged Interactive

Unit 1, Callywith Gate
Callywith Industrial Estate, Bodmin
Cornwall, UK
PL31 2RQ

+44 (0) 1726 981 123
www.rugged-interactive.co.uk
hello@rugged-interactive.co.uk

Congratulations!

Congratulations on your new Rugged Interactive product! Your customers are going to love this, and it is a great addition to your venue!

If there is anything we can assist with or if you would be interested in information about any other Rugged Interactive products, then please do not hesitate to get in contact.